

# Sona sCMOS

## Now Even Faster and More Sensitive

### Key Specifications

- ✓ Sensitive: 95% peak QE
- ✓ Fast: up to 135 fps
- ✓ Productive: up to 32 mm field of view
- ✓ Accurate: >99.7% linearity
- ✓ Protected: UltraVac™ sensor enclosure
- ✓ Longevity: 5-year vacuum warranty

### Key Applications

- ✓ Developmental biology
- ✓ Neuroimaging
- ✓ Super-resolution
- ✓ Transcriptomics
- ✓ Intracellular trafficking
- ✓ Plasma membrane studies



# Introducing Sona

## The most sensitive back-illuminated sCMOS Cameras

Sona is Andor's high performance, vacuum-cooled sCMOS camera platform, specifically for fluorescence microscopy. It has been designed from the ground up to extract the very best performance from the latest back-illuminated sCMOS sensors with 95% quantum efficiency.

**1 Extended QE Response**  
Back-illuminated sCMOS for highest possible photon collection. Capture every photon!

**8 Permanent Vacuum Seal Technology**  
The only back-illuminated sCMOS with permanent vacuum technology. Deepest cooling and longevity with 5 year seal warranty.\*



**2 Market Leading Quantitative Accuracy**  
Have confidence in your data with superb data fidelity:  
✓ >99.7% Linearity  
✓ <0.5% PRNU



**7 Uncompromised High Speeds**  
Capture dynamic events faster than ever. **New Sona-6 Extreme** high speed mode accelerates speeds up to 135 fps!

**3 True Imaging Flexibility**  
Select between 6.5 and 11  $\mu\text{m}$  pixel options. Capture fast or weak signals with ease. Pre-set ROIs and flexible binning options.



**4 Largest Imaging Area**  
Up to 32 mm Field of View! Unique Antiglow technology lets you harness the full field of view without restrictions!

**5 Camera based Super-resolution Capable**  
Unlock real-time cell friendly super-resolution from your microscope with SRRF-Stream+!

**6 Extended Dynamic Range (EDR)**  
One snap imaging captures full 16-bit image detail. Low-and high-level information in a single image!



# Sona-6 Extreme: Extreme Sensitivity & Speed

Sona-6 Extreme features a back-illuminated sensor with **95% QE** and a **6.5  $\mu\text{m}$**  pixel size. This sensor format provides a perfect balance of **sensitivity, speed, and resolution**. Exceptionally flexible, and ideally suited to 40x and 60x magnification and today's microscope port sizes. Compatible with SRRF-Stream+ Super-resolution.

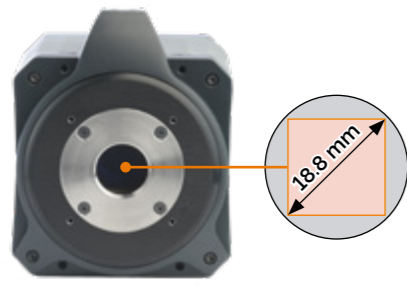

Sona-6 Extreme

Summary	
Model	4.2B-6
Sensor Size	18.8 mm
Pixel Size	6.5 $\mu\text{m}$
Quantum Efficiency	up to 95%
Read Noise	1.0 e- (Low Noise, 12-bit) 1.6 e- (High Dynamic Range, 16-bit) 1.9 e- (High Speed, 11-bit)
Dark Current	0.1 e-/p/s
Max. Speed	135 fps

## NEW & IMPROVED Capture the dynamics of life with Sona-6 Extreme

- ✓ **Accelerated speeds:** new high-speed mode accelerates speeds to **135 fps** (full frame) via CoaXPress to capture the fastest cellular processes.
- ✓ **Improved sensitivity:** the noise floor has been reduced by **25%**. Sensitivity is thus improved for better detection of the weakest signals.
- ✓ **Enhanced image quality:** PRNU has been reduced by 25% under low light conditions
- ✓ **Python ready** - Updated camera SDK integrates a Python wrapper for speedy integration.

## Intracellular Trafficking

Fast and sensitive imaging is crucial for studies of endosome cycling, Golgi vesicles pathways, axonal transport, hormone release or synaptic vesicle pool replenishment. Sona-6 Extreme with sensitivity, resolution and speed, is ideal for tracking intricate events and dependencies occurring within the cell's vital transport and communications networks.

Read more in our [Learning Center](#).

## Developmental Biology

Imaging has been instrumental for following the entire lifespan of organisms to track fates of developing cells, tissues, and organs. Whole-embryo and whole-body imaging of well-established model organisms including the zebrafish and *C. elegans* can be captured in superb detail with the Sona-6 Extreme camera. Read more in our [Learning Center](#).

## Neuroimaging

Imaging of neurons and other specialised cells of the nervous system can be challenging for many detectors. Experiments can require high dynamic range or very sensitive detectors. Sona cameras have the required sensitivity and dynamic imaging capabilities for neuroimaging experiments. Read more in our [Learning Center](#).

## Plasma Membrane Dynamics

The plasma membrane can be imaged in many ways, which can involve direct membrane labelling with lipophilic or voltage sensitive dyes. Rapid remodelling of the plasma membrane can be imaged with the rapid frame rate, highly sensitive back-illuminated Sona cameras, perfectly suited to the low light conditions inherent to TIRF Microscopy.

Read more in our [Learning Center](#).

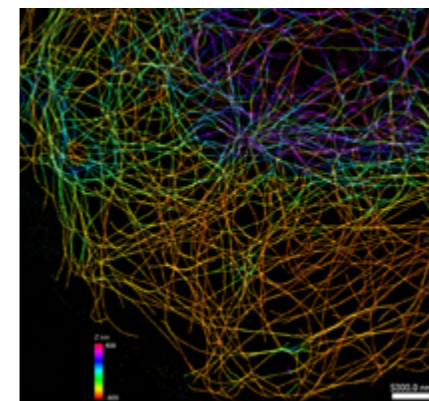

Super-resolution image of microtubules with B-TIRF. Image credit: F. Rivera-Molina, Yale University.

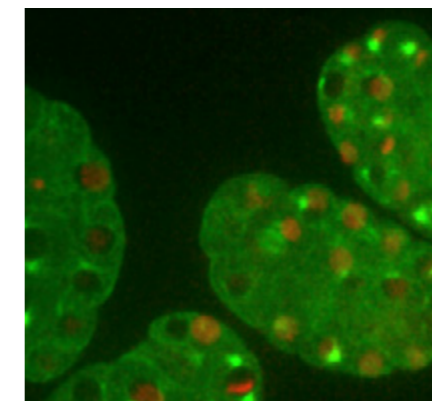

The early development of *C. elegans* embryos labelled with GFP and mCherry, captured at 60x with Sona-6. Image Andor Technology.

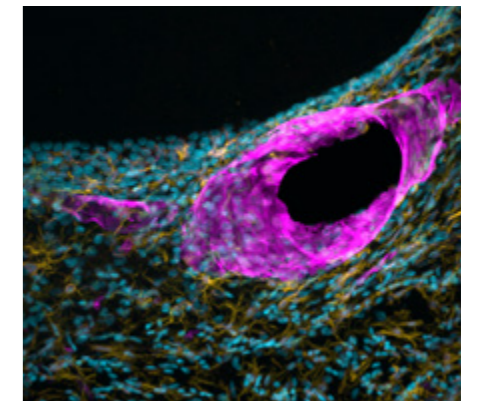

Organisation of neurons, astrocytes and glial cells within mouse brain, imaged with Sona at 40x. Image Andor Technology.

# Sona-11: For the Widest Field of View

Sona-11 has the **biggest sensor** on the market with a full **32 mm sensor diagonal!** Andor's unique technology usefully accesses the entire 2048 x 2048 array offering **62% larger** field of view than competing back-illuminated cameras. The **95% QE** and larger pixel size of **11 µm** provides optimal photon collection, for the **most light-starved applications**. Study structures and processes within the cell in perfect resolution using techniques such as confocal, TIRF and Single Molecule Localization Microscopy (SMLM).

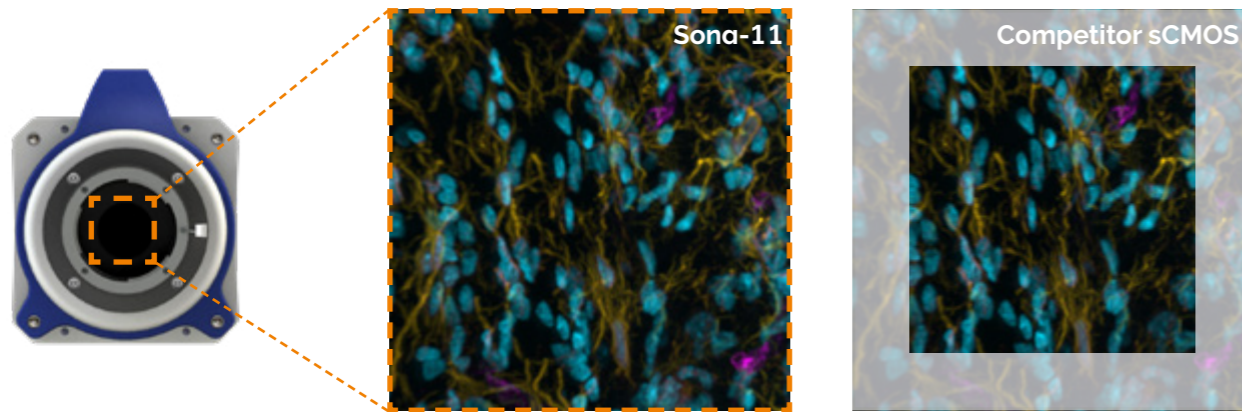

**See the full picture:** With a 32 mm sensor diagonal Sona-11 has a field of view advantage:

- ✓ **2.9x** larger field of view vs typical sCMOS
- ✓ **2.1x** larger field of view vs 22 mm format sCMOS
- ✓ **62%** larger field of view vs competing back-illuminated sCMOS (1608x1608 array)

- ✓ **Capture weak signals** – 95% QE is complemented by large 11 µm pixel size for optimal photon collection
- ✓ **SRRF-Stream+ Super-Resolution** - Transform a standard microscope to super-resolution!
- ✓ **NEW Python ready** - Updated camera SDK integrates a Python wrapper for speedy integration.

Summary		
Model	4.2B-11	2.0B-11
Sensor Size	32 mm	22 mm
Pixel Size	11 x 11 µm	
Quantum Efficiency	up to 95%	
Read Noise	1.6 e- median [1.8 e- rms]	
Dark Current	0.3 e-/p/s	
Max. Speed	48 fps	70 fps

## Single Molecule Imaging

Single molecule imaging experiments provide insights into processes that are not possible via normal ensemble imaging. Sona-11 is an alternative to EMCCD cameras when working with brighter labels and stronger signals. Sona-11 can provide significantly wider fields of view, higher speeds and exceptional dynamic range. Read more in our [Learning Center](#).

## Transcriptomics

Detectors for such studies must have high sensitivity to help detection of the fluorescent RNA signal against the cell background. Large fields of view and high-speed are also important to maximise throughput of the image data using microarrays or tissue samples. Sona-11 (32 mm) is ideal for these studies with its combination of high sensitivity, speed and widest possible field of view. Read more in our [Learning Center](#).

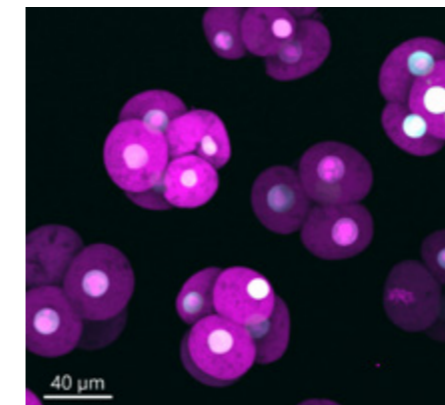

Mouse Fertilized eggs. Probe1: EGFP (EX/Em488nm/525-50nm), Probe2: Kusabira Orange (Ex/Em: 561/600-50nm) Microscope: Ti2-E (Nikon), Objective: 40x /1.25 (Sil), Camera: Sona-11, Pinhole Size 40 µm. *Sample courtesy of Dr. Eiichi Okamura, Shiga University of Medical Science*

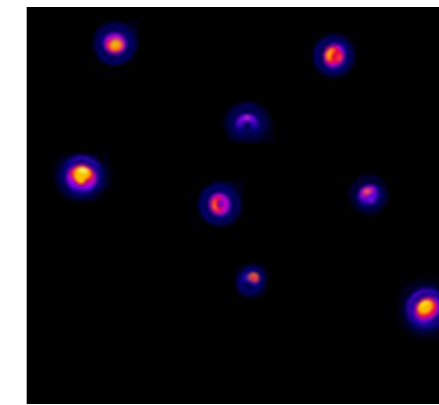

For the most demanding single molecule experiments EMCCD cameras are the most suitable. However, Sona-11 can be a viable option for stronger signals. *Image from Andor Technology.*

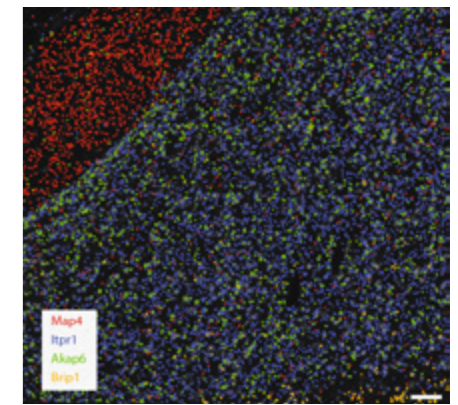

Decoded transcript locations of selected genes overlaid on stitched (n = 1 section per tissue). Scale bar, 100 µm. Split-FISH imaging repeated on at least one additional section per tissue, with similar results. Brain tissue showing differential localisation of transcripts in regions with (Itpr1) and without (Map4) cell bodies. *(Goh et al., 2020)*

## FCS

Sona-11 (32 mm) provides the best possible solution for many FCS experiments. The largest possible sensor area, high sensitivity and high speed are complemented by class leading linearity, which allow for the most accurate and precise measurements. Read more in our [Learning Center](#).

## Gene Editing

The best-in-class sensitivity offered by the back-illuminated deep cooled Sona sCMOS cameras are well suited to imaging of Crispr-Cas9 constructs, ideal for fast and sensitive detection of light emitted by labelled DNA/RNA or related proteins. Read more in our [Learning Center](#).



# Super-Resolution Ready

## SRRF-STREAM+

Want to enable fast and easy super-resolution down to 100 nm? Our exclusive camera-based technology enables super-resolution microscopy on conventional modern fluorescence microscopes in real-time.

SRRF (Super-Resolution Radial Fluctuations), is a highly effective approach to super-resolution developed by the Henriques research group (Gustafsson et al., 2016). Andor's unique and exclusive implementation of SRRF-Stream+ allows camera-based real-time super-resolution with low illumination intensities and normal fluorescent labels.



- ✓ **Capture vibrant images** – with stunning detail and high contrast.
- ✓ **Conventional fluorophores** – simple labelling, no photo-switching required.
- ✓ **Cost-effective** – convert conventional fluorescence microscopes to super-resolution microscopes.
- ✓ **Real time** – enhanced workflow, avoids post-processing. View in 'Live Mode'.
- ✓ **Low excitation intensities** – prolonged live cell observations & accurate physiology.

Read our [SRRF-Stream+ technical note](#) to find out more on how you can convert your microscope to super-resolution capabilities.

## STORM, PALM & DNA PAINT

The high sensitivity, low noise and high-speed capabilities of Sona are well suited to single molecule based 'STORM / PALM' and DNA PAINT approaches, revealing biological information down to ~10 nm.

*"I was impressed by how easy it is to produce beautiful super-resolution images with SRRF-Stream+ and Sona."*

*Motosuke Tsutsumi*

*"SRRF" super-resolution image taken with the Sona back-illuminated sCMOS camera, Andor Insight Awards, courtesy of Motosuke Tsutsumi, Research Institute for Electronic Science, Hokkaido University and National Institutes for Physiological Sciences, Aichi, Japan.*



# Technical Data<sup>•2</sup>

Model	Sona-11 (32 mm)	Sona -11 (22 mm)	Sona-6 Extreme
Sensor Type	Back-Illuminated Scientific CMOS		
Array Size	2048 (W) x 2048 (H) 4.2 Megapixel	1400 (W) x 1400 (H) 2.0 Megapixel	2048 (W) x 2046 (H) 4.2 Megapixel
Pixel Size	11 x 11 $\mu\text{m}$		6.5 x 6.5 $\mu\text{m}$
Image Area	22.5 mm x 22.5 mm (31.9 mm diagonal)	15.5 mm x 15.5 mm (21.8 mm diagonal)	13.3 mm x 13.3 mm (18.8 mm diagonal)
Readout Modes	Rolling Shutter		
Pixel Readout Rates	100 MHz (High Dynamic Range, 16-bit) 200 MHz (Fast Speed, 12-bit)	180 MHz (Low Noise, 12-bit) 310 MHz (High Dynamic Range, 16-bit) 570 MHz (High Speed 11-bit)	
Quantum Efficiency <sup>•3</sup>	up to 95%		
Read Noise (e <sup>-</sup> ) median	1.6 e <sup>-</sup> (at any readout rate)	1.0 e <sup>-</sup> (Low Noise, 12-bit) 1.6 e <sup>-</sup> (High Dynamic Range, 16-bit) 1.9 e <sup>-</sup> (High Speed, 11-bit)	
Sensor operating temperature <sup>•4</sup> Air cooled Water/liquid cooled	+15°C, -25°C +15°C, -25°C, -45°C	+0°C, -25°C +0°C, -25°C, -45°C	
Dark Current Air cooled (@-25°C) Water/liquid cooled (@-45°C)	0.7 e <sup>-</sup> /pixel/s 0.3 e <sup>-</sup> /pixel/s	0.15 e <sup>-</sup> /pixel/s 0.10 e <sup>-</sup> /pixel/s	
Active area pixel well depth	85000 e <sup>-</sup> (High Dynamic Range, 16-bit) 2600 e <sup>-</sup> (Fast Speed, 12-bit, bit depth limited)	42000 e <sup>-</sup> (High Dynamic Range, 16-bit) 1100 e <sup>-</sup> (Low Noise, 12-bit, bit depth limited) 1900 e <sup>-</sup> (High Speed, 11-bit)	
Dynamic Range	53000:1 (High Dynamic Range, 16-bit)	26250:1 (High Dynamic Range, 16-bit)	
Data Range	16-bit (High Dynamic Range) 12-bit (Fast Speed)	16-bit (High Dynamic Range) 12-bit (Low Noise)	
Linearity <sup>•5</sup>	> 99.7%		
PRNU	< 0.5% (@ half-light range)	< 0.3%	
Region of Interest (ROI)	User-definable, 1 pixel granularity, min. size 25 (w) x 1 (h)	User-definable, 1 pixel granularity, min. size 9 (w) x 1 (h)	
Pre-defined ROI	1608 x 1608, 1200 x 1200, 1024 x 1024, 512 x 512, 128 x 128	1024 x 1024, 512 x 512, 128 x 128	1608 x 1608, 1200 x 1200, 1024 x 1024, 512 x 512, 128 x 128
Pixel Binning (on FPGA)	2 x 2, 3 x 3, 4 x 4, 8 x 8 (user-definable binning also available)		

Model	Sona-11 (32 mm)	Sona -11 (22 mm)	Sona-6 Extreme
I/O	O: Fire Row 1, Fire Row n, Fire All, Fire Any, Arm, I: External		
Trigger Modes	Internal, External, External Start, External Exposure, Software		
Software Exposure Events <sup>•6</sup>	Start exposure - End exposure (row 1), Start exposure - End exposure (row n)		
Image Timestamp Accuracy	25 ns		
PC Interface	USB 3.0 <sup>•7</sup>		USB 3.0 <sup>•7</sup> and CoaXPRESS
Camera Window	AR coated UV grade fused silica window		
Lens Mount	F-mount	C-mount	

## Quantum Efficiency<sup>•3</sup>

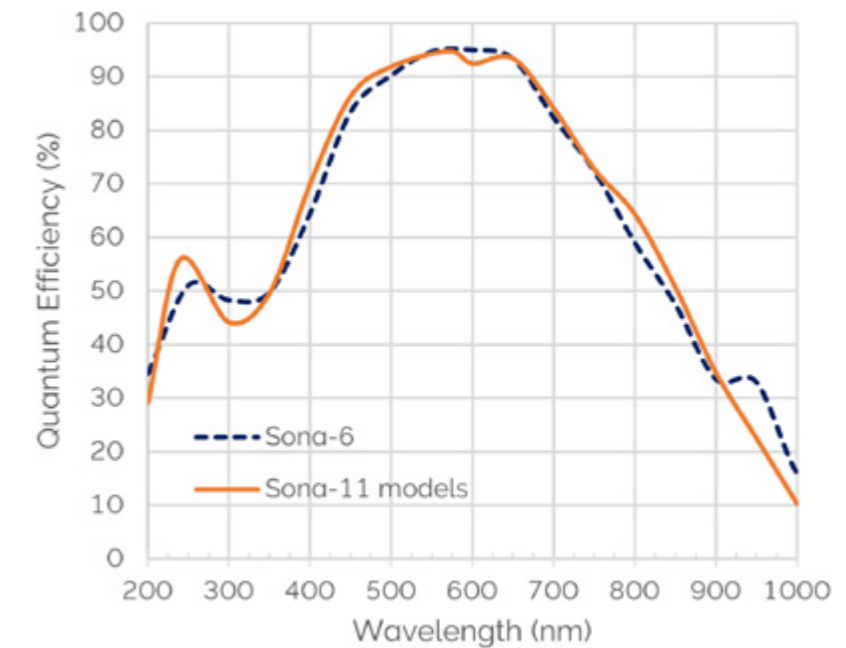

# Technical Data<sup>2</sup>

## Frame Rates

Max Frame Rate (fps)	Sona-11 (32 mm)		Sona -11 (22 mm)	
	16-bit	12-bit (Fast Speed)	16-bit	12-bit (Fast Speed)
ROI Size (W x H)				
2048 x 2048	24	48	-	-
1608 x 1608	30	61	-	-
1400 x 1400	35	70	35	70
1200 x 1200	41	81	41	81
1024 x 1024	48	95	48	95
512 x 512	95	190	95	190
256 x 256	190	378	190	378
128 x 128	378	750	378	750

Note: frame rates do not differ if partial or full rows are selected.

Sona-6 Extreme						
Max Frame Rate (fps)	Low Noise Mode 2-CMS (12-bit)		High Dynamic range Mode (16-bit)		High Speed Mode (11-bit)	
	USB	CXP	USB	CXP	USB	CXP
ROI Size (W x H)						
2048 x 2046	43	44	40	74	40	135
1024 x 1024	87	87	148	148	151	270
512 x 512	174	174	295	295	532	538
256 x 256	346	346	587	587	1046	1081
128 x 128	686	687	1165	1166	2032	2125

## Mechanical Drawings

Dimensions in mm [inches] (shown for C-mount)

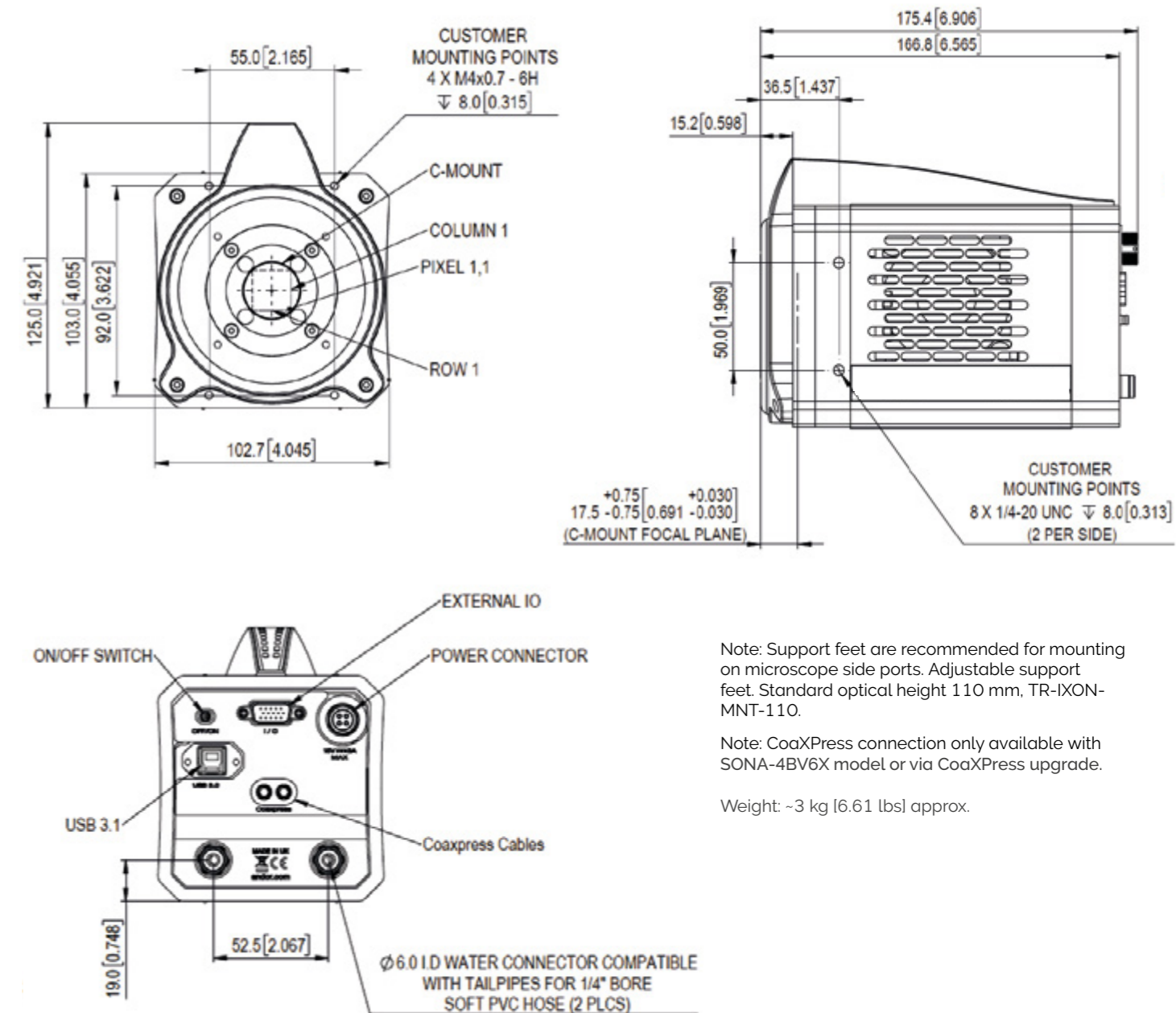

Note: Support feet are recommended for mounting on microscope side ports. Adjustable support feet. Standard optical height 110 mm, TR-IXON-MNT-110.

Note: CoaXPress connection only available with SONA-4BV6X model or via CoaXPress upgrade.

Weight: ~3 kg (6.61 lbs) approx.

# Creating the Optimum Product for you

## Step 1. Choose the camera type



Camera Type

Description	Code
Sona-11 (32 mm): 4.2 Megapixel Back-illuminated sCMOS, 11 µm pixel, 95% QE, 48 fps, USB 3.0, F-mount*, SRRF-Stream+ ready	<b>SONA-4BV11</b>
Sona -11 (22 mm): 2.0 Megapixel Back Illuminated sCMOS, 11 µm pixel, 95% QE, 70 fps, USB 3.0, C-mount, SRRF-Stream+ ready	<b>SONA-2BV11</b>
Sona-6 Extreme: 4.2 Megapixel Back Illuminated sCMOS, 6.5 µm pixel, 95% QE, 43 fps, USB 3.0, C-mount, SRRF-Stream+ ready	<b>SONA-4BV6U</b>
Sona-6 Extreme: 4.2 Megapixel Back Illuminated sCMOS, 6.5 µm pixel, 95% QE, 135 fps, USB 3.0 and CoaXPress, C-mount, SRRF-Stream+ ready	<b>SONA-4BV6X</b>

\* Optional user-switchable C-Mount accessory available for use with smaller ROI sizes.

## Step 2. Select the required accessories



Accessories

Description	Order Code
SRRF-Stream+ real time super-resolution for Sona-6* <sup>8</sup>	<b>SRRF-STREAM-SONA-6</b>
SRRF-Stream+ real time super-resolution functionality for Sona-11 (32 mm) or -11 (22 mm)* <sup>8</sup>	<b>SRRF-STREAM-SONA-11</b>
C-mount - convert Sona-11 (32 mm) to C-mount (for use with ROIs)	<b>ACC-MEC-11936</b>
F-mount - replacement F-mount kit	<b>F-MOUNT-ADP-KIT</b>
2x magnifying coupler unit for Sona-11 (32 mm) models for: Leica microscopes Nikon (TiE and Ti2) microscopes Olympus microscopes	<b>MCU-SONA-LEI</b> <b>MCU-SONA-NIK-TI</b> <b>MCU-SONA-OLY</b>
Support feet recommended for side port mounting. Standard optical height 110 mm	<b>TR-IXON-MNT-110</b>
Re-circulator for enhanced cooling performance (supplied with 2x2.5 m tubing as standard)	<b>XW-RECR</b>
Oasis 160 Ultra compact chiller unit (tubing to be ordered separately)	<b>ACC-XW-CHIL-160</b>
6 mm tubing options for Oasis 160 Ultra compact chiller (2x2.5 m or 2x5 m lengths)	<b>ACC-6MM-TUBING-2X2.5</b> <b>ACC-6MM-TUBING-2X5M</b>
Pair of barbed hose inserts for 6 mm tubing	<b>6MM-HOSE-BARBS</b>

## Step 3. Select the required software



Software

Sona requires one of the following software options:

**Fusion** Fully featured yet intuitive acquisition software. Integrated workflow to Imaris.

**Solis Imaging** A 32-bit and fully 64-bit enabled application for Windows (8.1 and 10) offering rich functionality for data acquisition and processing. AndorBasic provides macro language control of data acquisition, processing, display and export.

**Andor SDK3** A software development kit that allows you to control the Andor range of cameras from your own application. Available as 32/ 64-bit libraries for Windows (8.1 and 10) and Linux. Compatible with C/C++, C#, Delphi, VB.NET, LabVIEW, MATLAB and Python..

**Third party software compatibility** Drivers are available for a variety of third party imaging packages. [See the Andor website for detail](#)

## Upgrades



Upgrades

Order SRRF-Stream+ for Sona

Order codes for SRRF-Stream+ on your current Sona:

<b>Sona-6:</b>	<b>SRRF UPGRADE SONA-6</b>
<b>Sona-11:</b>	<b>SRRF UPGRADE SONA-11</b>

CoaXPress Upgrade

To upgrade USB 3.0 model to higher speed CoaXPress order **CHAM-UPG-CXP** code. Upgrade includes CoaXPress card, cables and remote session to upgrade camera firmware to unlock CoaXPress. Please contact your sales representative for more information.



# Order Today

At Andor we are committed to finding the correct solution for you. With a dedicated team of technical advisors, we are able to offer you one-to-one guidance and technical support on all Andor products.

For a full listing of our local sales offices, please see: [andor.oxinst.com/contact](http://andor.oxinst.com/contact)

Our regional headquarters are:

## Europe

Belfast, Northern Ireland  
Phone +44 (28) 9023 7126  
Fax +44 (28) 9031 0792

## North America

Concord, MA, USA  
Phone +1 (860) 290 9211  
Fax +1 (860) 290 9566

## Japan

Tokyo  
Phone +81 (3) 6732 8968  
Fax +81 (3) 6732 8939

## China

Beijing  
Phone +86 (10) 5884 7900  
Fax +86 (10) 5884 7901

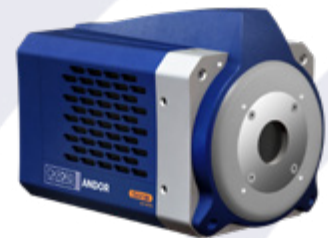

## Items shipped with your camera

- 1x USB 3.0 PCIe card\*
- 1x USB 3.0 Cable (3 m)\*
- 1x Multi I/O Timing Cable (BNC to D-type: 1.5 m)
- 1x 15 V PSU
- 1x Country specific power cord
- 1x User manuals in electronic format
- 1x Quickstart Guide
- 1x Individual system performance booklet
- Sona-6 with CoaXPress also includes:
- 1x CoaXPress 3.0 PCIe card with external trigger
- 1x CoaXPress Cable (3 m)
- 1x Multi I/O Timing Cable (BNC to SMB: 1.5 m)

## Minimum Computer Requirements:

- 3.0 GHz single core or 2.4 GHz dual or quad core processor
- 8 GB RAM
- Hard drive: 850 MB/sec write speed recommended for the data rate associated with the max. frame rates. 250 MB free hard disc to install software
- USB 3.0 slot (or x4 PCIe slot for USB 3.0 card)
- x8 PCIe slot for CXP PCIe card
- Windows (8.1 and 10) or Linux

## Footnotes

1. Assembled in a state-of-the-art facility, Andor's UltraVac® vacuum process combines a permanent hermetic vacuum seal (no o-rings), with a stringent protocol and proprietary materials to minimise outgassing. Outgassing is the release of trapped gases that would otherwise degrade cooling performance and potentially cause sensor failure.
2. Figures are typical unless otherwise stated.
3. Quantum efficiency as supplied by the sensor manufacturer.
4. Coolant temperature must be above dew point.
5. Linearity is measured from a plot of Signal vs. Exposure Time over the full dynamic range.
6. Software Exposure Events provide rapid software notification (SDK only) of the start and end of acquisition.
7. The Sona connects to your control PC using a USB 3.0 connection. This may also be referred to as USB 3.1 (Gen 1). Andor provide a USB 3.0 card and cable, and recommend that these are used to ensure optimum performance.
8. Camera must be connected to suitable acquisition workstation with compatible Nvidia GPU card and supported software.

## Operating & Storage Conditions:

- Operating Temperature: 0°C to +30°C ambient
- Operating Altitude: up to 6000 m
- Relative Humidity: <70% (non-condensing)
- Storage Temperature: -10°C to 50°C

## Power Requirements:

- 100 - 240 VAC, 50 - 60 Hz
- Power consumption: 40 - 46 W typical / 114 W max (model dependent)

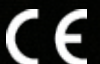

Windows is a registered trademark of Microsoft Corporation.  
LabVIEW is a registered trademark of National Instruments.  
MATLAB is a registered trademark of The MathWorks Inc.