

Industrial

SZX16/SZX10 Research Stereo Microscope System

Outstanding Optical Performance
in an Ergonomic Design



EVIDENT

A New Dimension of Industrial Microscopy

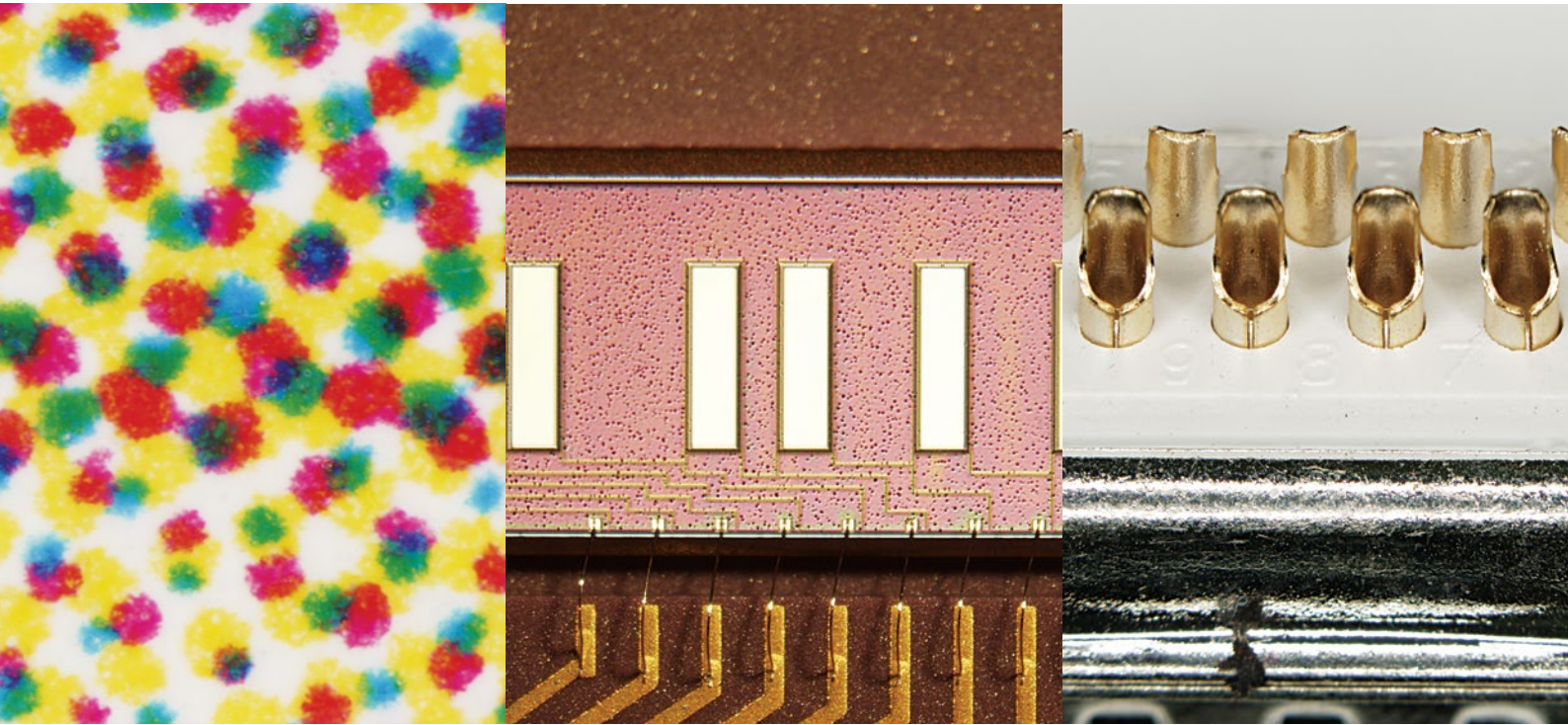

With advanced optics, superior quality, and an innovative ergonomic design, the SZX series is built to handle your industrial imaging needs. From observation to analysis to digital imaging, the SZX series provides the increased efficiency and productivity required for industrial R&D and quality analysis.

- Refined Optical Performance
 - SZX16 P4-P7
 - SZX10 P8-P9
- Ergonomic Design for Working Comfort P10-P11
- Varied Illumination Technology P12-P15
- Digital Imaging P16-P18
- Accessories P19
- Specifications P20-P21
- System diagram P22-P23



SZX16 Standard base set



SZX10 Ergonomic set

By combining ergonomic instrumentation with the power of Galilean optics, our SZX series enables user to comfortably perform advanced stereomicroscopy tasks for extended periods of time. New ergonomic accessories bring the microscope closer to the user and provide flexibility for individuals of different heights. Providing a comfortable position for each user during microscope work reduces stress during observation and increases efficiency.

New levels of comfort are achieved without any reduction in image quality. The wide zoom range and increased focal depth optimize image quality and user productivity.

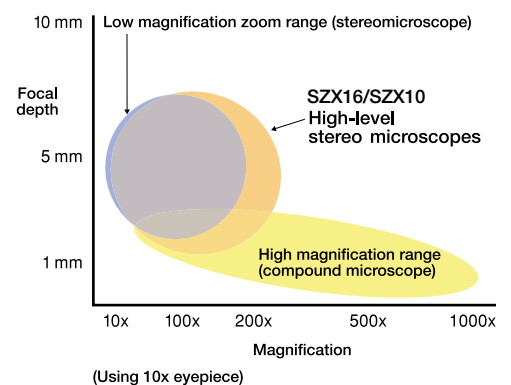

Refined Optical Performance Supports
a Wide Zoom Range and Exceptional Image Clarity

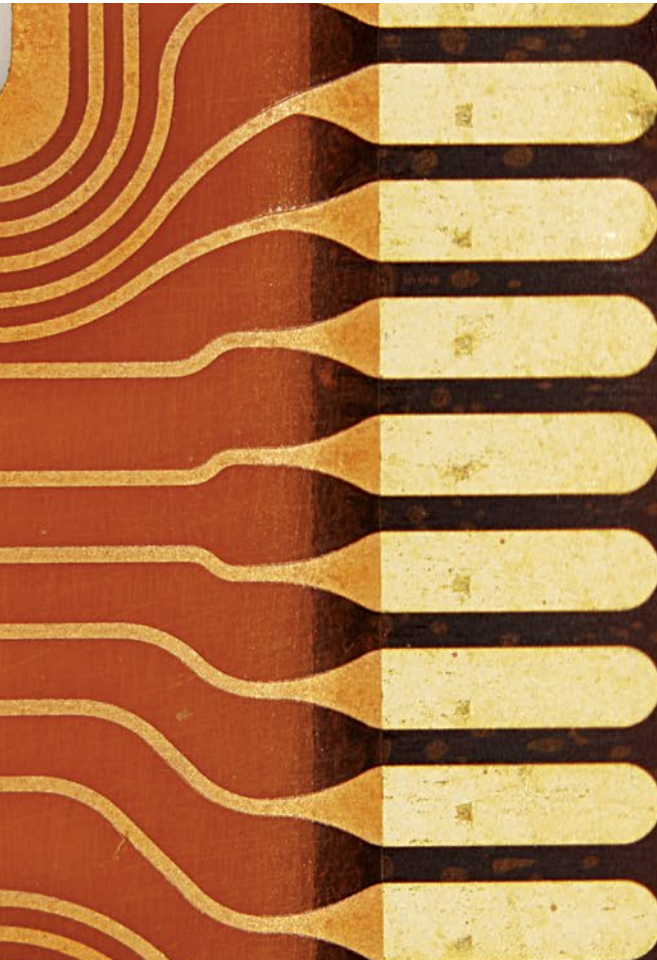

Wide Zoom Ratio (16.4:1) for Clear Viewing of Samples from Overview to Microstructural Observation

The SZX16 microscope is crafted to the highest optical standards. A wide zoom range of 0.7X–11.5X enables clear observations from overview to microstructures. When revolving objectives are used, even higher resolution magnifications are available.

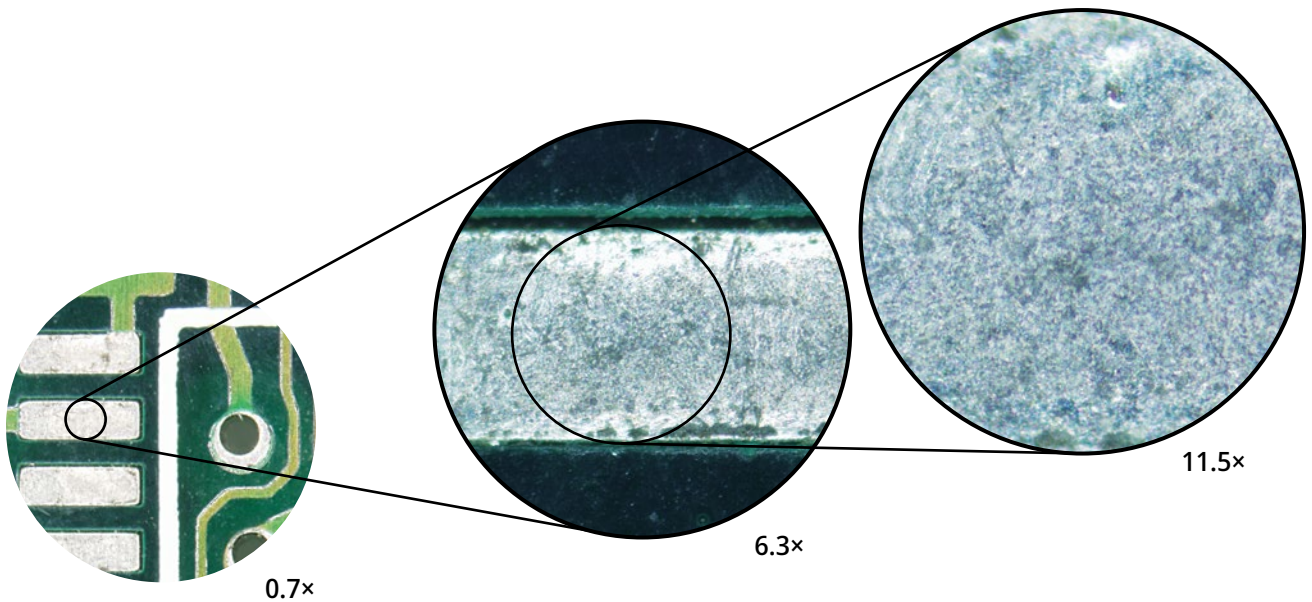

Improved Image Clarity at the Most Frequently Used Magnification

Resolution at the most frequently used magnification setting (middle range) is 30% better than previous our stereo microscopes. Improved brightness enables the high image clarity needed for research in advanced materials and electronics.

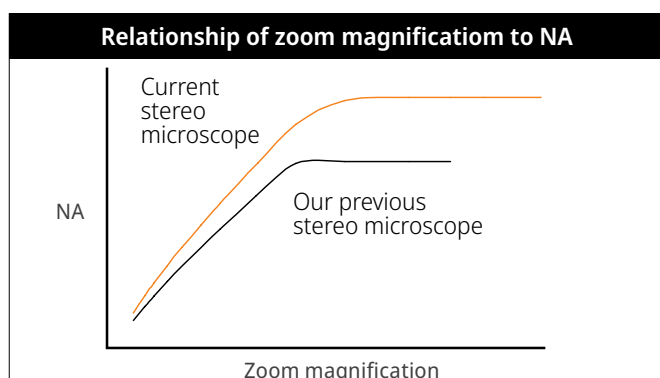

Expanded Zoom Ratio with a Revolving Nosepiece

The revolving nosepiece (SZX2-2RE16) incorporates parfocal (PF) objective lenses for observation at different magnifications. Using PF objective lenses enables quick and minimal focusing when switching between them.



Variable Focus Depth from the Built-In AS Zoom Body for Observation and Image Capture

The ability to control the built-in aperture stop (AS) enables the user to optimize sample viewing for contrast and resolution and is especially useful for samples that have uneven structures.

See More with SDF (Super Depth of Focus) Series Objective Lenses

The six SDF objective lenses use special dispersion glass to provide outstanding stereoscopic viewing.

Leading-Edge SDF Objectives

By effectively eliminating astigmatism, the SDF series achieves high-quality stereoscopic viewing with less defocusing. The six-piece lineup of 0.3X, 0.5X, 0.8X, 1X, 1.6X, and 2X objective lenses provide a wide range of observation between 2.1X–230X (with a 10X eyepiece)—all conveniently available in one stereo microscope.



Top row, from right: SDFPLAPO2XPFC, SDFPLAPO1.6XPF, SDFPLAPO1XPF2
Bottom row, from right: SDFPLAPO0.8X, SDFPLAPO0.5XPF, SDFPLFL0.3X

Model	W.D. (mm)	Total magnification*
SDFPLFL0.3X	141	2.1X–34.5X
SDFPLAPO0.5XPF	70.5	3.5X–57.5X
SDFPLAPO0.8X	81	5.6X–92X
SDFPLAPO1XPF	60	7X–115
SDFPLAPO1.6XPF	30	11.2X–184X
SDFPLAPO2XPFC	20	14X–230X

* Using 10× eyepieces; 15× through 30× eyepieces are optional.

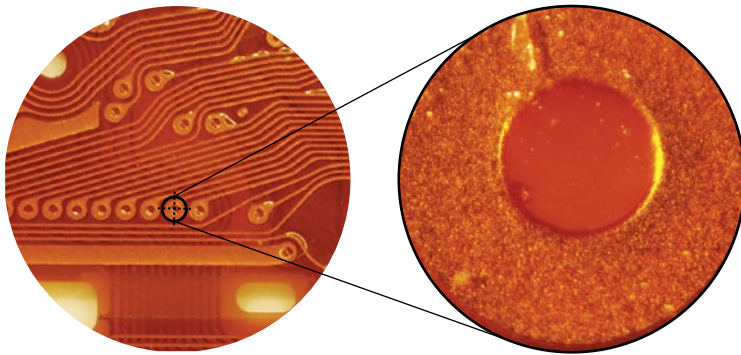

High Resolution at 900 Lines/mm with SDFPLAPO2XPFC

The SDFPLAPO2XPFC objective lens attains a high resolution at 900 lines/mm, resolved down to 1.1 μm lines.



Previous our stereo microscope

SZX16 (with SDFPLAPO2XPFC)

Distortion-Free Design Minimizes Image Curvature

A distortion-free design lowers curvature/distortion, enabling true observation of flat samples within a field of view.

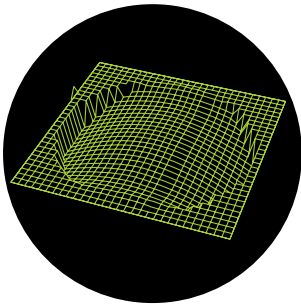

Conventional design

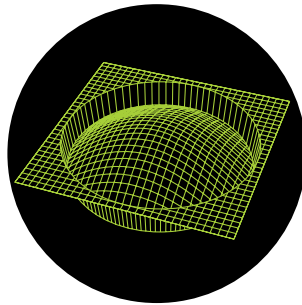

Distortion-free design

High NA (0.15) and Long W.D. (60 mm) with 1X Objective Lens

SDFPLAPO1XPF objective lenses provide both a high numerical aperture (NA) (0.15) and long working distance (60 mm).



Apochromatic Design Corrects for Chromatic Aberration

The characteristics of the apochromatic system—integrated into tubes, zoom body, and objective lenses—eliminate chromatic aberration and ensure excellent color reproduction for all zoom ranges.



Uncorrected apochromatic viewing



Apochromatic viewing

Astigmatism-Free Design for Clear Stereoscopic View

An astigmatism-free design integrated throughout the system effectively prevents the astigmatism that deforms images appearing in tubes, the zoom body, and objective lenses. Increased focus depth enables clear observation at high magnifications.



SZX16

Cost-Effective Combined with Superior Performance and Ease of Use

The SZX10 cost-effective stereo microscope offers outstanding versatility and ease of use. Two apochromatic objective lenses are standard. The 1X objective lens has an 81 mm working distance (W.D.) for operational comfort and a 0.1 numerical aperture (NA) for excellent optical performance. The 1.25X objective lens is useful for many purposes. The lens' chromatic-aberration correction provides clear and distinct images.

High Zoom Ratio (10:1)

Our proprietary optical design technologies are integrated throughout the microscope to achieve a high 10:1 zoom ratio of 0.63X–6.3X. Progress through a range of magnifications without switching objective lenses.

Built-in AS Zoom Body

The fully adjustable aperture stop (AS) can be used to increase focus depth; especially useful when observing tall samples.



Aperture stop of zoom body

1.25X Objective Lens for High Magnification and Resolution; 1X Objective Lens for a Wider Field of View and Longer W.D.

These high-quality apochromatic lenses designed for the SZX10 microscope are useful for a variety of observation tasks and applications.



Objective lenses: 1x for task efficiency



1.25x for high magnification and optimal NA

System-Wide Astigmatism-Free Design for Clear Observation

Incorporating an astigmatism-free design throughout the system effectively prevents the astigmatism that deform tube, zoom, and objective lens images.

Selection of Powerful SZX10 Objective Lenses

Our objective lenses are designed to be equally responsive to different sample needs. Eight SZX10 objective lenses offer magnification from 0.5X to 2X. Users have a variety of observation choices all in a single microscope, ranging from 3.2X to 126X with 10x eyepieces. In addition, two lenses come standard with the revolving nosepiece (SZX2-2RE10).



SZX10



Top row, from right: DFPLAPO1.25X, DFPL1.5X-4, DFPL2X-4
 Center row, from right: SZX-ACH1X, SZX-ACH1.25X-2
 Bottom row, from right: DFPL0.5X-4, DFPL0.75X-4, DFPLAPO1X-4

Model	W.D. (mm)	Total magnification*
DFPL0.5X-4	171	3.2X-31.5X
DFPL0.75X-4	116	4.7X-47.3X
DFPLAPO1X-4	81	6.3X-63X
SZX-ACH1X	90	6.3X-63X
DFPLAPO1.25X	60	7.9X-78.9X
SZX-ACH1.25X-2	68	7.9X-78.9X
DFPL1.5X-4	45.5	9.5X-94.5X
DFPL2X-4	33.5	12.6X-126X

* Using 10x eyepieces; 15x through 30x eyepieces are optional.

Ergonomic Instrumentation* Increases User Comfort During Extended Work Sessions



*Comform to SEMI S8 standards

Tilting Trinocular Observation Tubes with Optimized Convergence Angle Minimize Eye and Neck Strain

Trinocular tubes provide comfortable and efficient observation.

Whether seated or standing, observers can adjust the tilting trinocular tube to efficiently perform long-duration observation.

Natural Posture, Reduced Stress, and Increased Productivity

The ergonomic long tilting trinocular provides an optimized work position by bringing the microscope closer to the user, while the extendable eyepoint adjuster provides flexibility for users of different heights. The SZX series' ergonomic instruments reduce stress during observation by providing the most comfortable position for each user, increasing work efficiency.

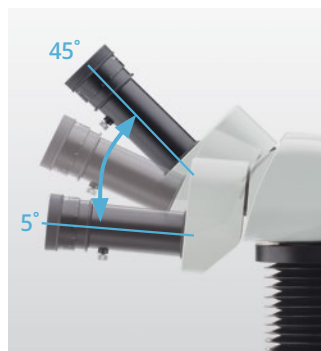

Tilting range of SZX2-TTR



SZX2-EEPA

Tube Convergence Angle Relieves Eyestrain

Our research established a correlation between stereomicroscopic optical systems and eyestrain. A convergence angle using right and left optical paths without compensation can cause discomfort. The convergence angle in the SZX series, however, completely compensates for each optical path. This solution effectively eliminates eyestrain during prolonged observation.

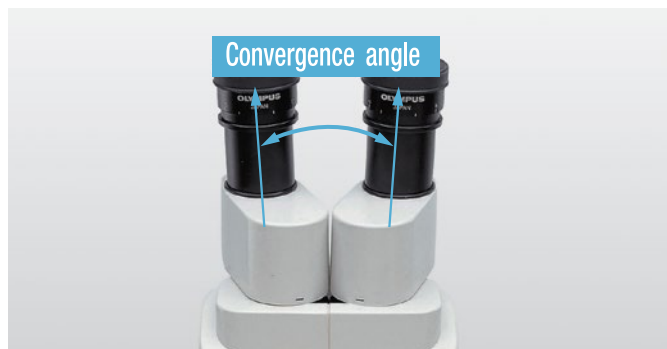

Ergonomic Zoom and Focus Knobs for Fatigue-Free Use

The position of the zoom knob, size and position of the coarse/fine focusing knob, and the fine focus stroke have all been redesigned for easier operation. This enhancement of the fine focus stroke results in easy and precise focusing.



Ergonomic coarse/fine focusing knob

Slim Design Illumination Base for Easy Access to Samples

Illumination bases are designed to not only be easy to use, but also fatigue-free. The slim LED transmitted light illumination base, at approximately 41.5 mm in height, features easily adjustable fingertip illumination control and provides easy access to samples.



Slim design illumination base

Long-Life LED Illumination Accurately Reproduces Colors for Optimal Imaging

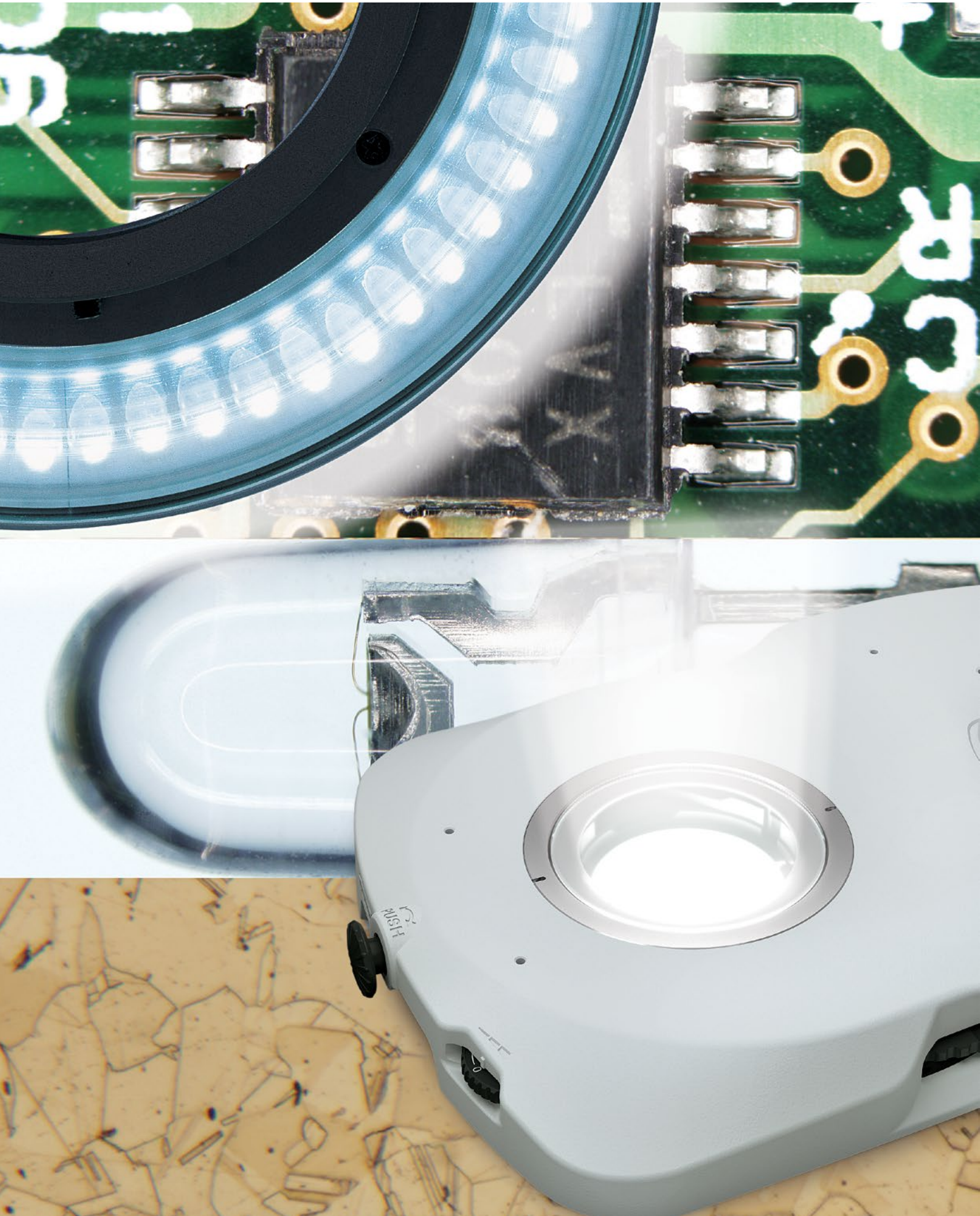

Advanced Brightfield Transmitted Light

The LED light illumination base provides a long life of about 60,000 hours. You can choose between multiple cartridges for various applications and incorporate up to 4 filters in the base and change between them with a simple turn. The base's thin design helps reduce stress during observation.



Advanced transmitted light illumination base (SZX2-ILLTQ)

Product	Observation and Contrast Methods
① SZX2-CBFL	Brightfield, low-contrast
② SZX2-CBF	Brightfield, standard
③ SZX2-CBFH	Brightfield, high-contrast
④ SZX2-COBL	Oblique, low-contrast
⑤ SZX2-COB	Oblique, standard
⑥ SZX2-COBH	Oblique, high-contrast
⑦ SZX2-CSH	Shade plate
⑧ SZX2-CDF	Darkfield
⑨ SZX2-CPO	Polarization plate

SZX16-RFA Fluorescence Light Illumination System for Advanced Fluorescence Imaging

High NA Provides Bright Fluorescent Observation

A near-vertical reflected light illumination system produces illumination that is almost coaxial to the observation path and enables substantially improved excitation light efficiency. These features provide an average of two to three times better fluorescent observation than conventional stereo microscopes at all magnifications. In addition to using reflected light, transmitted light can also be used for sample confirmation.

Five-Position Turret with Nine-Filter Selection

The fluorescence illumination system for the SZX16 has five-position turrets with a five-filter selection for different samples. Nine fluorescent filter units capture the details of bright and high-contrast fluorescent images.



Choose the Illumination Source that Suits Your Sample

Our light solutions work for many different tasks with sources such as transmitted, reflected, ring light, and fluorescence illumination. Offering consistently bright and stable illumination, the SZX system meets reflected light requirements with a coaxial illumination system, a dual flexible light guide, and a ring light guide, among others. These choices enable users to do a broad array of stereo microscope observations and documentation.

Various Reflected Light Illumination Systems

Dual Combination Light Guide (LG-DFI)

The top-mounted dual light guide is easy to position and keeps workspaces uncluttered. This system maintains the selected illumination position when focusing.



Dual contrast light guide on SZX16

Coaxial Illumination System (SZX2-ILLC16/SZX2-ILLC10)

This illumination system is ideal for detecting imperfections on highly reflective samples such as integrated circuits, photonic products, and medical devices.



SZX16 Coaxial illuminator

Dual Interlock Light Guide (LG-DI)

With this unit, users can view select areas with pinpoint accuracy and optimal viewing conditions.



Ring Light Guide (LG-R66)

This ring light guide provides bright, clear, and even illumination from several angles, eliminating obstructive sample shadowing.



Ring light guide on SZX16

Objective Lenses with an Access Angle of 51 Degrees

(Objective Lenses for SZX16: SDFPLAPO1.6XPF, SDFPLAPO2XPFC)

Light-guide illumination with short working distance (W.D.) objective lenses make effective illumination difficult. Objective lenses set at 1.6X and 2X with a 51-degree access angle enable optimum illumination.



Industrial research requires the precision that LED illumination provides for a variety of inspection and sample needs. Reproducing natural light, white LED delivers constant color temperature, and the LED ring illuminator offers high contrast observation and variable lighting for ease of use. Our long-life LEDs reduce maintenance and improve imaging results.

LED Four-Part Ring Illumination Unit (SZX2-ILR66)

High-intensity LED illumination is an extremely bright light source that reproduces natural light for optimal observation. This LED illumination system provides even illumination plus a variable selection of lighting for ease of use. By choosing from an illuminator divided into four lighting zones, users can choose full, 3/4, 1/2, and 1/4 lighting for a total of thirteen patterns; the user does not need to move the sample for optimal viewing and documentation. Thanks to fan-less ventilation of the power supply, the LED illumination system is compatible with clean rooms. In addition to ESD compatibility that helps keep samples free from static electricity damage, the manual control unit is easily operated by hand, providing user comfort.

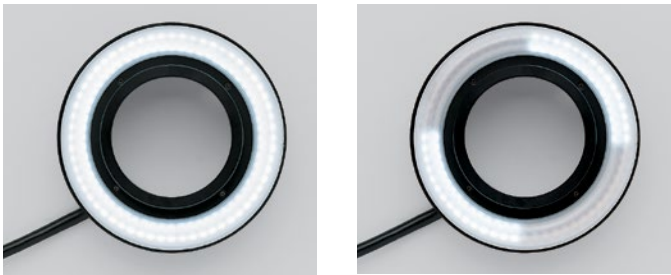

The exclusive control for the LED ring illumination system offers the freedom to direct 13-pattern LED lighting for optimum observation. 3/4, 1/2, and 1/4 lighting patterns move in circular rotation and in mirror symmetry via pad control. The ergonomic design of the unit is perfectly suited to fingertip operation.

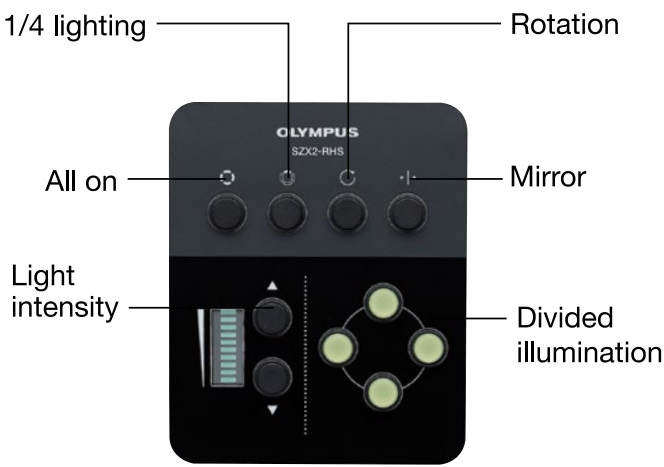

SZX2-RHS, the control pad for LED 4-part ring illumination unit



Four-part illumination of surface fracture (metal)

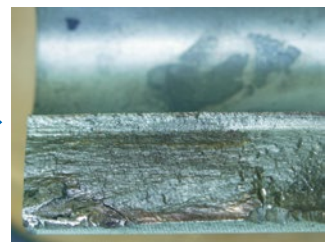

Upper-portion illumination of surface fracture (metal)

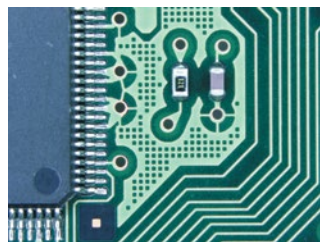

Four-part illumination of PWB

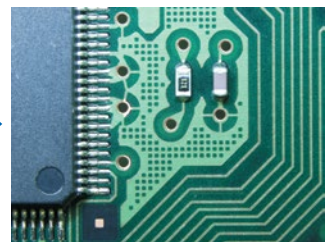

Right-quadrant illumination of PWB

Enhanced Power with Sophisticated Digital Cameras and Image Analysis Software

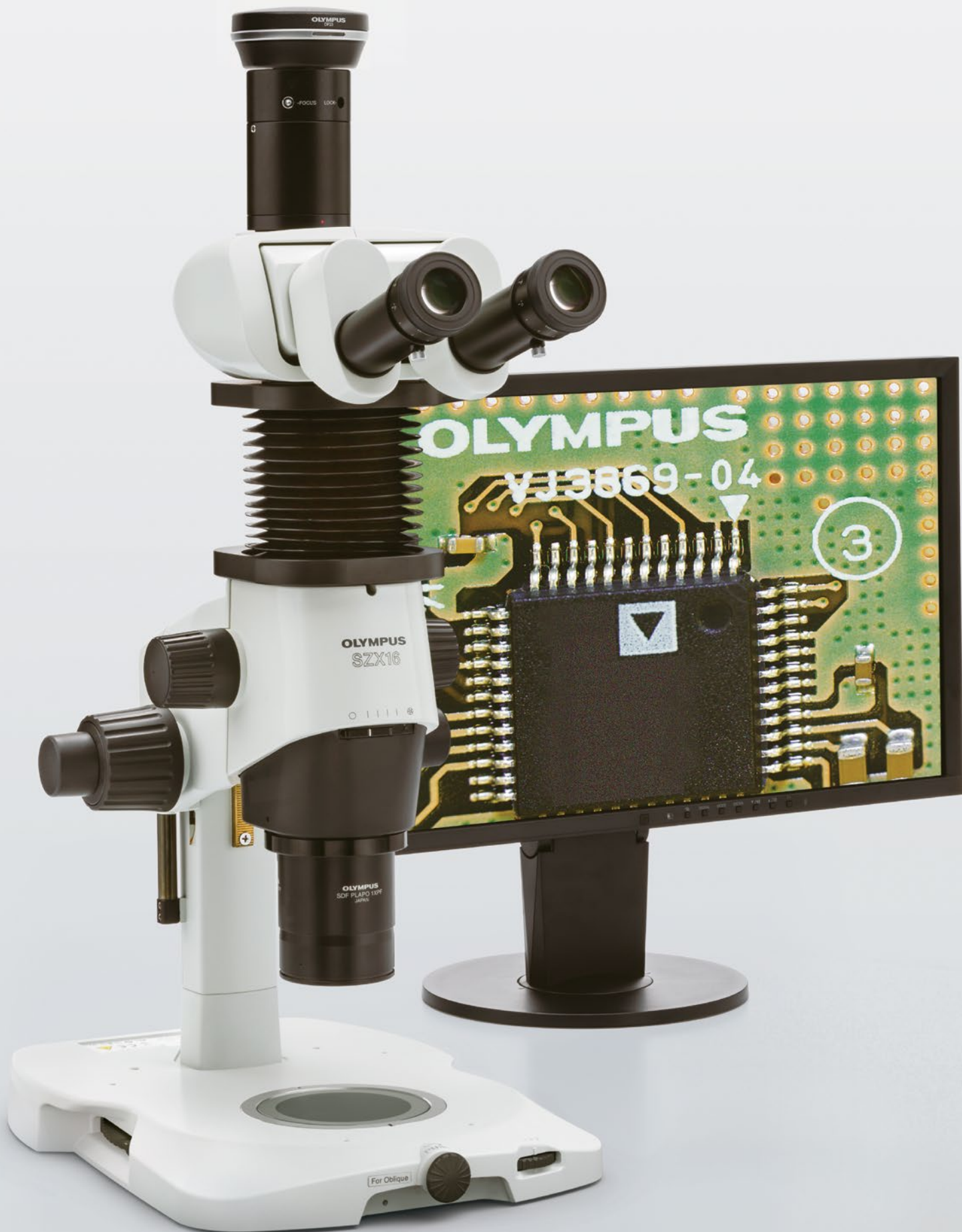

Digital technology is a total synergy of our optics, microscope digital cameras, and image analysis software. Vertical observation provides excellent images.

DP74 High-Resolution Digital Camera

The DP74 color camera supports advanced functions to capture high-quality images of samples. The camera combines a wide field of view with a diagonal length of 21 mm with full HD image resolution at 60 frames per second (fps). The camera's CMOS sensor has a global shutter that exposes the whole pixel at the same time. Even when moving the stage, there is no distortion like rolling shutter CMOS, which exposes, and reads line by line. The result is that users can acquire sample images quickly and easily. The DP74 camera is optimized for fluorescence imaging with a powerful noise reduction function and a high level of gain sensitivity. With the position navigator, you'll always know your location in the sample, even without a motorized stage.



DP28 Digital Camera

The DP28 digital microscope camera combines powerful features, precise color accuracy, and up to 4K resolution across a wide field of view to provide high-resolution images of your inspection samples that are free from artifacts. Make your inspections fast and efficient with images that are sharp and clear, even when moving the stage.



DP23 High-Speed, Compact Digital Camera

This 6.4-megapixel color CMOS camera combines high image quality with precise color accuracy and convenient features to make your industrial inspection workflow easier. Providing advanced functions balanced with outstanding value, the DP23 camera is instrumental to perform almost any industrial imaging application.

Vertical observation

The revolving nosepieces for SZX16 (SZX2-2RE16) and SZX10 (SZX2-2RE10) may be used for standard stereomicroscopic observation as well as vertical observation, which accommodates the overlap of lens center and optical axis. Lens-centered observation results in aberration-free images. Defocusing is effectively eliminated for 3D rendering by image processing software.

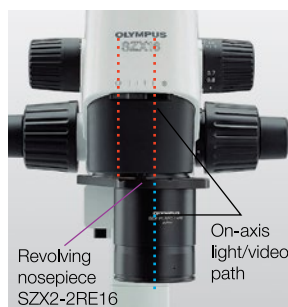

The nosepiece enables vertical observation.

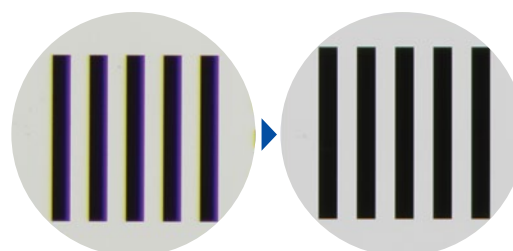

Ordinary observation (image)

Vertical observation

PRECiV Imaging and Measurement Software: A New Standard for Workflow Flexibility

PRECiV Imaging and Measurement software enables you to seamlessly acquire images and process and measure them via a stereo microscope with a digital camera. The system provides you with the flexibility to meet your needs without changing your operation. You can execute not just simple measurements, but panoramic view, extended focus, and particle analysis.

Optimized Focus and Exposure

The PRECiV focus indicator enables users to select a region of interest and bring it into optimum focus using the focus control of the microscope. This function is essential when a large optical depth of field makes it difficult to find the best focus position by eye. PRECiV software's live histogram display and overexposure indicator make it easy to find the optimum exposure time to avoid overexposed images that cause a loss of detail. Your digital camera's exposure time can then be adjusted manually or automatically when using the family of our DP series cameras.

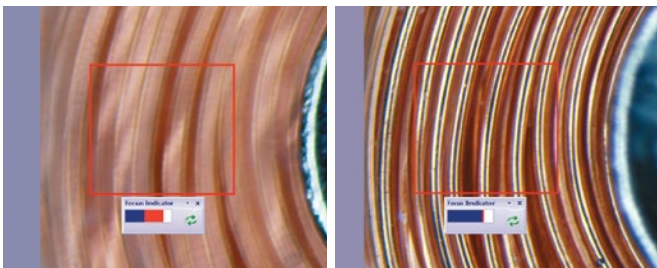

Unfocused

Focused

Instant Extended Focus Image (EFI)

PRECiV software provides images for samples that extend beyond the standard depth of focus. The instant Extended Focus Image enables you to use the fine focus adjustment to combine many images at different z-levels to provide you with a single combined image that is entirely in focus.



Perfectly focuses image of mechanical parts of a watch

Manual Multiple Image Alignment (MIA)

PRECiV software provides Multiple Image Alignment (MIA) for the creation of panoramic images of samples that extend beyond the field of view. PRECiV software quickly stitches them together, providing you with an output ready for visualization or complex measurement. Simultaneous use of instant EFI is also possible.

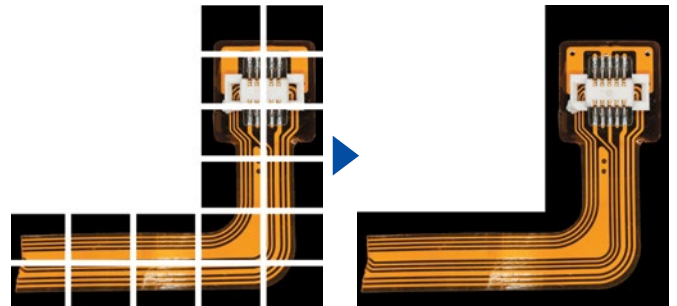

Multiple image acquisition of a flexible board

Count and Measure

Object detection and size distribution measurement are among the most important applications in digital imaging. PRECiV incorporates a detection engine that utilizes threshold methods to reliably separate objects (e.g., particles, scratches) from the background. PRECiV offers more than 50 parameters for shape, size, position, and pixel properties (intensity, gray value) for object classification.

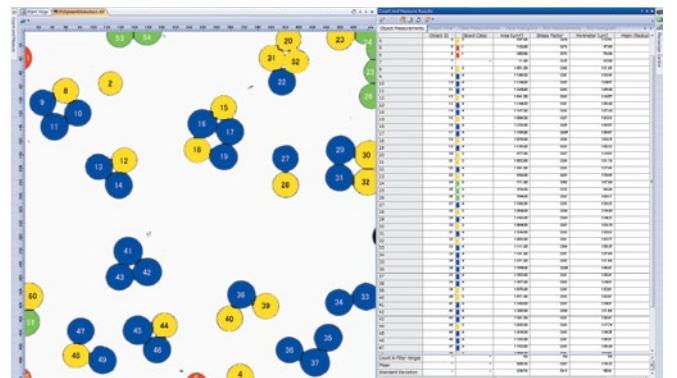

Object detection and classification

Please refer to the PRECiV catalog for further details

A Range of Accessories to Extend the Width of Observation Customizable for Various Applications (SZX16 / SZX10)



SZX16 Universal stand



SZX16 Large stand

Universal Stand with ESD* Compatibility (SZX-STU2)

This stand is designed for observation and digital imaging of samples too large for standard-size stands. The design, based on dual horizontal poles and linear ball bearings, ensures smooth horizontal movement and rotation. The mechanism can be tilted forward, backward, right, and left, enabling a quick and precise approach to the chosen observation area.

*ESD = Electric Static Discharge

Large Stand (SZX2-STL)

This large stand exhibits excellent stability, making it optimized for image capture as well as observation of large samples.



U-SRG2, SZX-STAD1



U-SIC4R2, U-MSSPG, U-MSSP4, SZX-STAD-2



BH2-SH, SZH-STAD1

BX Stage Adapter Type 1 (SZX-STAD1)

Enables use of the BX53M rotating stage (U-SRG2) with various SZX stands and transmitted light illuminators. This is especially valuable in polarized observations and image capture.

BX Stage Adapter Type 2 (SZX-STAD2)

Enables use of a BX53M mechanical stage with various SZX stands and transmitted light illuminators. Particularly suitable for accurate X-Y movement of samples.

BH Stage Adapter Type 1 (SZH-STAD1)

Enables use of a BH2 mechanical stage (BH2-SH) with various SZX stands and transmitted light illuminators. Particularly suitable for accurate X-Y movement of samples.



Specifications

SZX16/SZX10 Specifications

Item	Specifications					
	SZX2-ZB16			SZX2-ZB10		
Zoom microscope body	Zoom ratio: 16.4 (0.7X–11.5X) Magnification indication: 0.7/0.8/1/1.25/1.6/2/2.5/3.2/4/5/6.3/8/10/11.5			Zoom ratio: 10 (0.63X–6.3X) Magnification indication: 0.63/0.8/1/1.25/1.6/2/2.5/3.2/4/5/6.3		
	Zoom variable magnification system with parallel optical axis Zoom drive system: Horizontal handle click-stop for various zoom positions incorporated					
	Manual zoom body (SZX2-ZB16, SZX2-ZB10)					
	AS: Built-in					
	Objective mounting: screw mount					
Objective	For SZX2-ZB16			For SZX2-ZB10		
	Objectives	NA	W.D. (mm)	Objectives	NA	W.D. (mm)
	SDFPLFL0.3X	0.045	141	DFPL0.5X-4	0.05	171
	SDFPLAPO0.5XPF	0.075	70.5	DFPL0.75X-4	0.075	116
	SDFPLAPO0.8X	0.12	81	DFPLAPO1X-4	0.1	81
	SDFPLAPO1XPF	0.15	60	SZX-ACH1X	0.1	90
	SDFPLAPO1.6XPF	0.24	30	DFPLAPO1.25X	0.125	60
	SDFPLAPO2XPFC	0.3	20	SZX-ACH1.25X-2	0.125	68
				DFPL1.5X-4	0.15	45.5
			DFPL2X-4	0.2	33.5	
Eyepiece	WHN10X-H FN 22		WHSZ15X-H FN 16		WHSZ10X-H FN 22	
	WHSZ20X-H FN 12.5		WHSZ30X-H FN 7		WHSZ15X-H FN 16	
Observation tube	SZX2-TTR/SZX2-TTRPT: Tilting trinocular tube Convergence angle, Tilting angle: 5°–45°, Interpupillary distance adjustment: 52–76 mm, 2-step optical path (selectable) (TTR observation: straight port = 100:0, 50:50) (TTRPT observation: straight port = 100:0, 0:100)					
	SZX2-TR30/SZX2-TR30PT: 30-degree trinocular tube Convergence angle, Tilting angle: 30°, Interpupillary distance adjustment: 52–76 mm, 2-step optical path (selectable) (TR30 observation: straight port = 100:0, 50:50) (TR30PT observation: straight port = 100:0, 0:100)					
	SZX2-LTTR: Ergonomic Long Tilting Trinocular** Convergence angle, Tilting angle 5°–45°, Interpupillary distance adjustment: 57–80 mm, 2-step optical path (selectable) (straight port = 100:0, 50:50)					
	—			SZX-BI30: 30° binocular tube Tilting angle: 30° Interpupillary distance adjustment: 51–76 mm		
—			SZX-BI45: 45° binocular tube Tilting angle: 45° Interpupillary distance adjustment: 52–76 mm			
Focusing assembly	SZX2-FO: Focusing unit / focus: rack and pinion with roller guide (with torque adjustment ring for coarse focusing), optional counter balance, coarse handle stroke: 80 mm, coarse handle stroke per rotation: 21 mm, Load capacity: 0.0–10.0 kg (0–22 lb)					
	SZX2-FOF: Fine focusing unit / focus: rack and pinion with roller guide (with torque adjustment ring for coarse focusing), coarse and fine coaxial handle, built-in counter balance, coarse handle stroke: 80 mm, coarse handle stroke per rotation: 36.8 mm, fine handle stroke: 80 mm, fine handle stroke per rotation: 0.77 mm, load capacity: 2.7–15.0 kg (6–33 lb)					
	SZX2-FOFH: Fine focusing unit for heavy loading / focus: rack and pinion with roller guide (with torque adjustment ring for coarse focusing), coarse and fine coaxial handle, built-in gas spring counter balance, coarse handle stroke: 80 mm, coarse handle stroke per rotation: 36.8 mm, fine handle stroke: 80 mm, fine handle stroke per rotation: 0.77 mm, load capacity: 8.0–25.0 kg (17.6–55 lb)					
Extendable Eyepoint adjuster	SZX2-EEPA: Height adjustment range: 30–150 mm (with a scale attached)					
Stand	SZX2-ST: Standard stand / Pillar height: 270 mm, base dimension (W × D × H) : 284 mm x 335 mm x 31 mm (11.2 in. x 13.2 in. x 1.2 in.), Stage clips are mountable, with stage adapter fixing screw holes					
	SZX2-STL: Large stand / Pillar height: 400 mm, base dimension (W × D × H) : 400 mm x 350 mm x 28 mm (15.7 in. x 13.8 in. x 1.1 in.), Stage clips are mountable, with stage adapter fixing screw holes					

*4 SZX2-LTTR: intermediate magnification is 1.25X.

Transmitted Illumination Base Specifications

Item	Specifications	
	SZX2-ILLTQ	SZX2-ILLTS
Light source	White LED (Average service life: about 60,000 hours by rated use.)	
Light intensity adjustment	Continuously variable system	
Effective illuminated area	Brightfield (Low contrast): φ63 mm, Brightfield (Standard/High)/Darkfield/Oblique/Polarized: φ35 mm	
Option filter	φ45mm filter (for SZX2-CBF/SZX2-CBFH)	
Illumination mode	Selection by changing cartridges (Cartridges are option.), Brightfield illumination (Low/Standard/High contrast), Darkfield illumination, Oblique illumination (Low/Standard/High contrast), Polarized illumination	
Contrast selection	Low/Standard/High (Brightfield/Oblique)	
Turret position number for illumination base	4	1
The height of stage (from desk surface)	41.5 mm	
Pillar height	268.5 mm	
Weight	Approx. 4.1 kg (9.2 lb)	Approx. 3.8 kg (8.6 lb)
Power source	AC100-240 V, 50/60 Hz (AC adapter)	

Transmitted Illumination Base Specifications

Type	LED ring illuminator SZX2-ILR66	Ring light guide LG-R66	Dual light guide LG-DFI/DI	Coaxial illuminator SZX2-ILLC16/10
Features	4-part LED ring illumination 4-part independent ON/OFF available	Bright, uniformly lit images without glaring reflections or obscuring shadows	Flexible illumination for any angle and position	Bright high-contrast coaxial illumination. Effective for observing structure, such as imperfections on metal surfaces, patterns on IC or LCD
Illumination specifications	Rotary, mirror function, ESD capability, RoHS compatibility, Class 1	Installation diameter: 66 mm Flexible part: 1000 mm Attachment adapter*: SZX-LGR66 *No adapter required for SZX16-LGR66 *Unable to attach to SDFPLAPO2XPFC/ SDFPLAPO1.6XPF	LG-DFI: Flexible part 1000 mm Inter-lock part 500 mm LG-DI: Inter-lock part 500 mm	Magnification factor: 1.5X Light guide: LG-DF Flexible part 1000 mm 1/4 wavelength retardation plate included
Light source specifications	10 -segment light intensity volume, fan-less ventilation, AC 100–240 V	Type: LG-LSLED (LED light source for light guide) Functions: Continuous Electronic Dimming (0–100%), Filter slider, Silent fan, Power Consumption: max. 37 VA Operating Voltage, Frequency: 90–264 V, 47–63 Hz Dimension (W × D × H): 231 mm x 114 mm x 137 mm (9.1 in. x 4.5 in. x 5.4 in.) Weight: Approx. 2.45 kg (5.4 lb) Input Voltage: AC100–240 V, 50/60 Hz (AC adapter)		
Options	SZX-LGR66, adapter for SZX10	—	HLL301: Collector lens	—

Total Magnifications And Actual Field Diameters of SZX2-ZB16*1

Objective	Eyepiece							
	WHN10X-H		WHS15X-H		WHS20X-H		WHS30X-H	
	total mag.	field diameter (mm)	total mag.	field diameter (mm)	total mag.	field diameter (mm)	total mag.	field diameter (mm)
SDFPLFL0.3X	2.1X–34.5X	∅104.8–∅6.4	3.2X–51.8X	∅76.2–∅4.6	4.2X–69X	∅59.5–∅3.6	6.3X–103.5X	∅33.3–∅2.0
SDFPLFL0.5XPF	3.5X–57.5X	∅62.9–∅3.8	5.3X–86.3X	∅45.7–∅2.8	7X–115X	∅35.7–∅2.2	10.5X–172.5X	∅20.0–∅1.2
SDFPLAPO0.8X	5.6X–92X	∅39.3–∅2.4	8.4X–138X	∅28.6–∅1.7	11.2X–184X	∅22.3–∅1.4	16.8X–276v	∅12.5–∅0.8
SDFPLAPO1XPF	7X–115X	∅31.4–∅1.9	10.5X–172.5X	∅22.9–∅1.4	14X–230X	∅17.9–∅1.1	21X–345X	∅10.0–∅0.6
SDFPLAPO1.6XPF	11.2X–184X	∅19.6–∅1.2*2	16.8X–276X	∅14.3–∅0.9	22.4X–368X	∅11.2–∅0.7	33.6X–552X	∅6.3–∅0.4
SDFPLAPO2XPFC	14X–230X	∅15.7–∅1*2	21X–345X	∅11.4–∅0.7*2	28X–460X	∅8.9–∅0.5	42X–690X	∅5.0–∅0.3

*1 SZX2-LTTR: intermediate magnification is 1.25X *2 Some vignetting may occur from optical characteristics. This occurs in observations at low magnification.

Total Magnifications and Actual Filed Diameters of SZX2-ZB10*3

Objective	Eyepiece							
	WHN10X-H		WHS15X-H		WHS20X-H		WHS30X-H	
	total mag.	field diameter (mm)	total mag.	field diameter (mm)	total mag.	field diameter (mm)	total mag.	field diameter (mm)
DFPL0.5X-4	3.2X–31.5X	∅69.8–∅7.0	4.7X–47.3X	∅50.8–∅5.1	6.3X–63X	∅39.7–∅4	9.5X–94.5X	∅22.2–∅2.2
DFPL0.75X-4	4.7X–47.3X	∅46.6–∅4.7	7.1X–70.9X	∅33.9–∅3.4	9.4X–94.5X	∅26.5–∅2.6	14.2X–141.8X	∅14.8–∅1.5
DFPLAPO1X-4 SZX-ACH1X	6.3X–63X	∅34.9–∅3.5	9.5X–94.5X	∅25.4–∅2.5	12.6X–126X	∅19.8–∅2	18.9X–189X	∅11.1–∅1.1
DFPLAPO1.25X SZX-ACH1.25X-2	7.9X–78.9X	∅27.9–∅2.8	11.8X–118.1X	∅20.3–∅2	15.8X–157.5X	∅15.9–∅1.6	23.6X–236.3X	∅8.9–∅0.9
DFPL1.5X-4	9.5X–94.5X	∅23.3–∅2.3	14.2X–141.8X	∅16.9–∅1.7	18.9X–189X	∅13.2–∅1.3	28.4X–283.5X	∅7.4–∅0.7
DFPL2X-4	12.6X–126X	∅17.5–∅1.7	18.9X–189X	∅12.7–∅1.3	25.2X–252X	∅9.9–∅1	37.8X–378X	∅5.6–∅0.6

*3 SZX2-LTTR: intermediate magnification is 1.25X

Dimensions

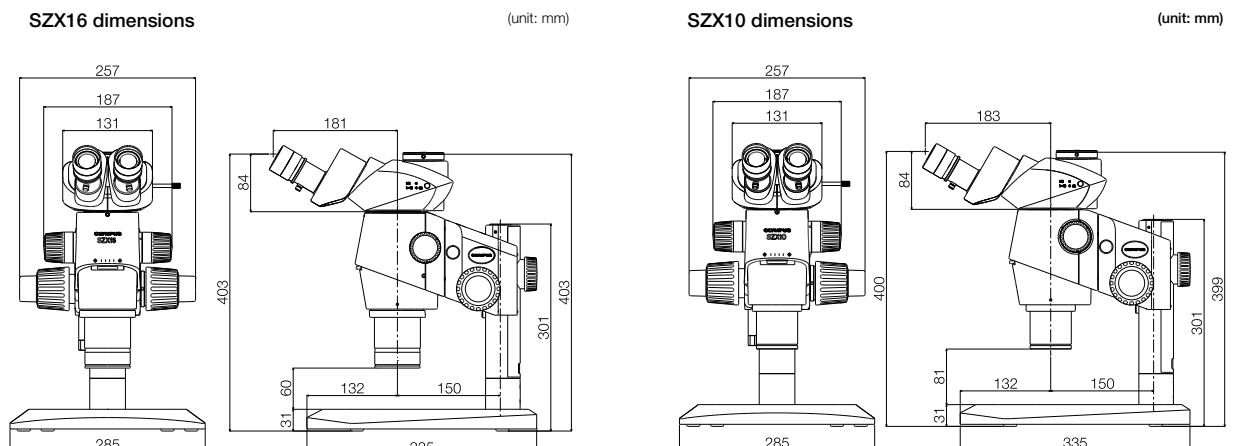

System Diagram

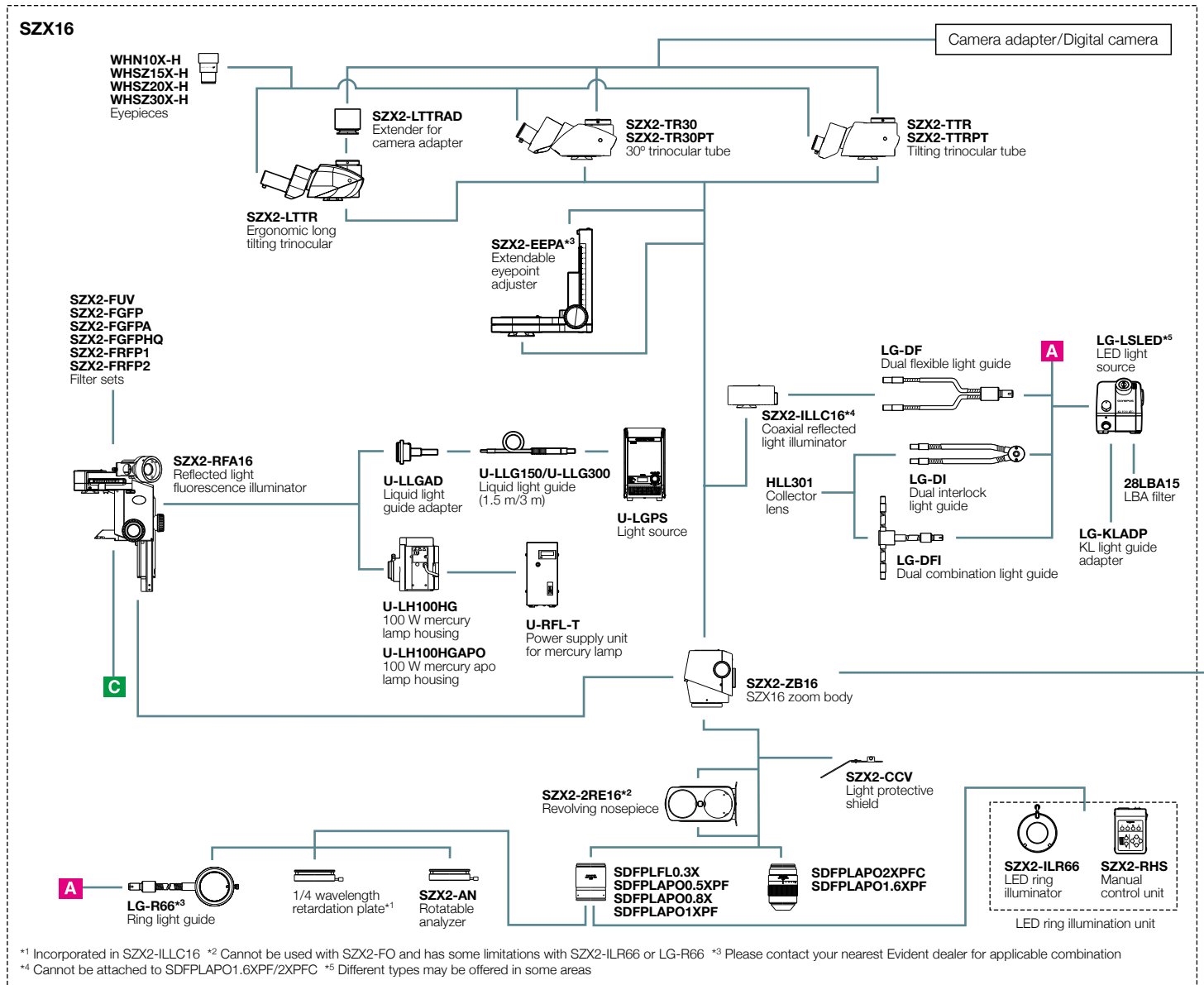

*1 Incorporated in SZX2-ILLC16 *2 Cannot be used with SZX2-FO and has some limitations with SZX2-ILR66 or LG-R66 *3 Please contact your nearest Evident dealer for applicable combination *4 Cannot be attached to SDFPLAPO1.6XPF/2XPF *5 Different types may be offered in some areas

Accessories

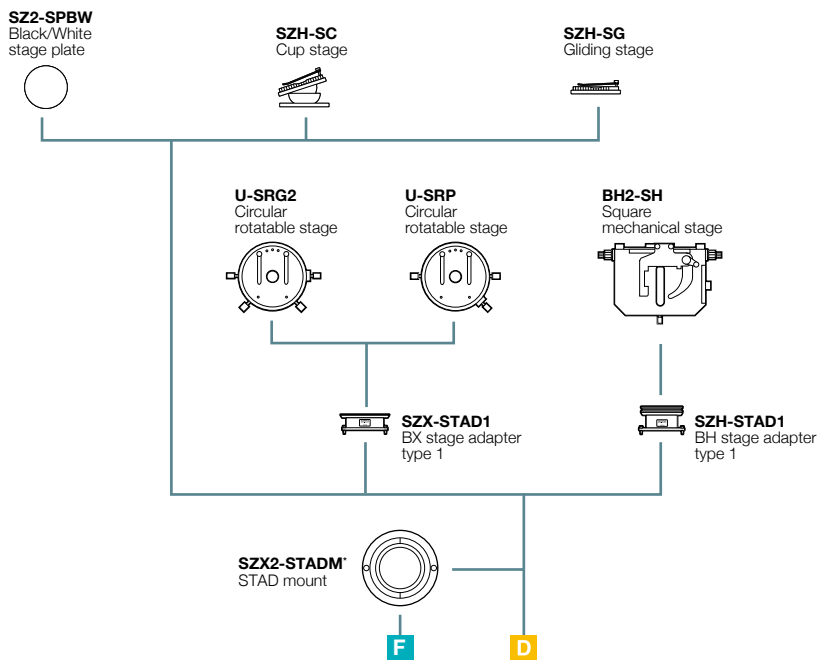

* Cannot be used with SZ2-SPBW

Focusing units



Illuminators

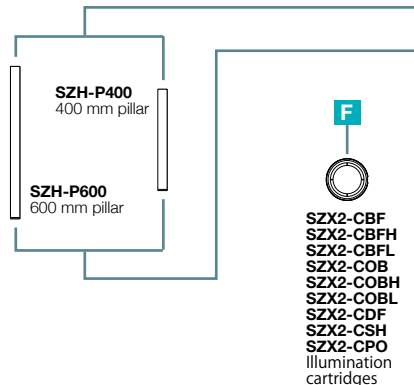

SZX10

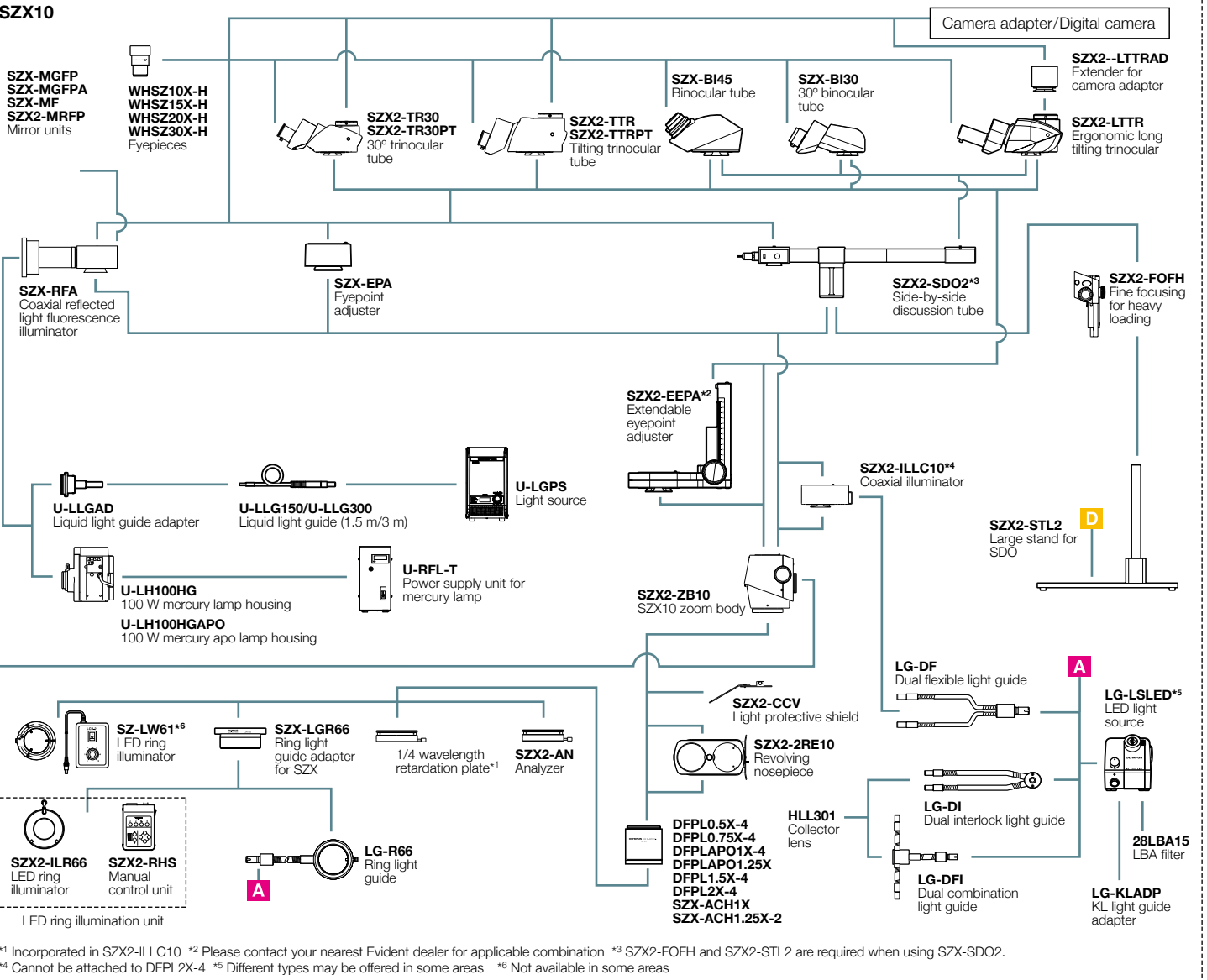

*1 Incorporated in SZX2-ILLC10 *2 Please contact your nearest Evident dealer for applicable combination *3 SZX2-FOFH and SZX2-STL2 are required when using SZX-SDO2.
*4 Cannot be attached to DFPL2X-4 *5 Different types may be offered in some areas *6 Not available in some areas

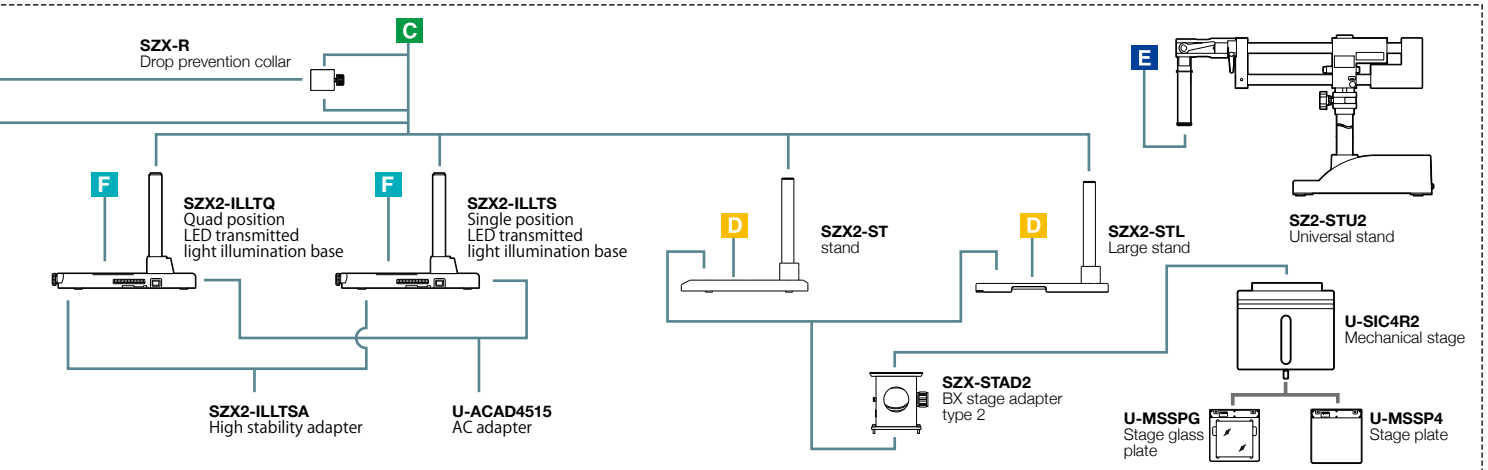



Evident Corporation
Shinjuku Monolith, 2-3-1 Nishi-Shinjuku,
Shinjuku-ku, Tokyo 163-0910, Japan

Evident Scientific, Inc.
48 Woerd Avenue
Waltham, MA 02453, USA
Tél. : (1) 781-419-3900

Evident Corporation is ISO14001 certified. Evident Corporation is ISO9001 certified.
All company and product names are registered trademarks and/or trademarks of their respective owners.
Images on the PC monitors are simulated.
Illumination devices for microscope have suggested lifetimes. Periodic inspections are required. Please visit our web site for details. Specifications and appearances are subject to change without any notice or obligation on the part of the manufacturer.
Copyright © 2023 Evident Corporation